

Three Decoder Mounting Kit-A x 2

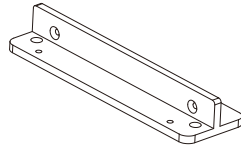

Three Decoder Mounting Kit-B x 2



KM3\*8 x 20



M5\*16 x 4

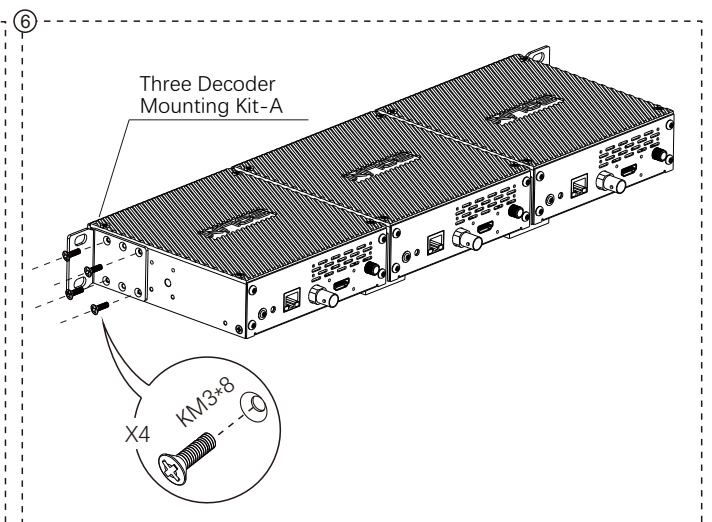
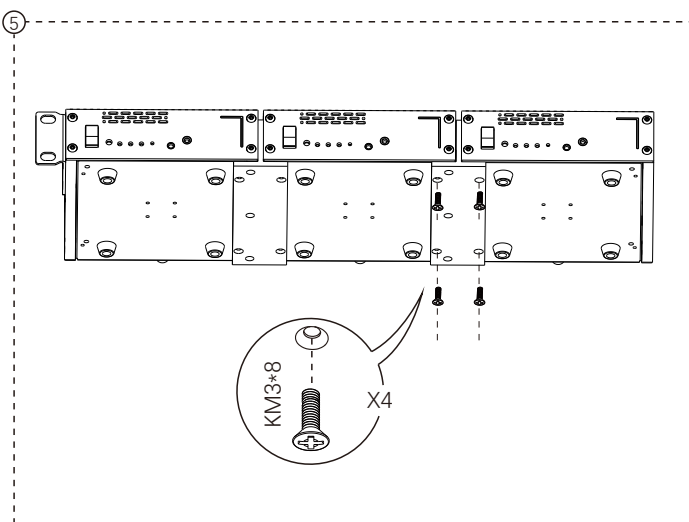
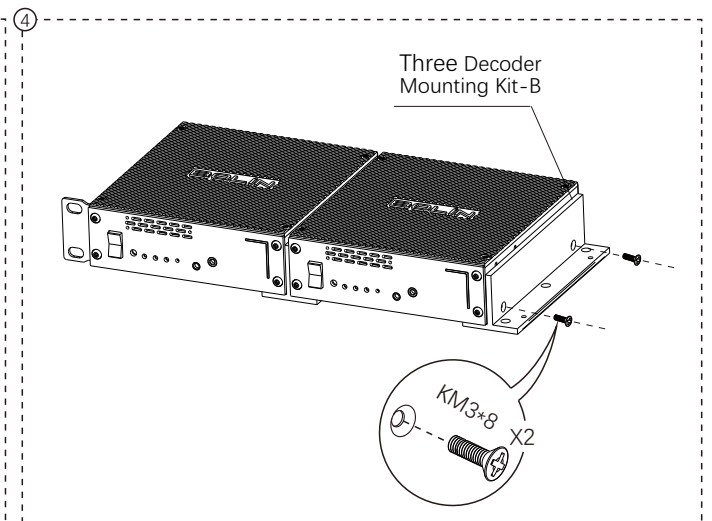
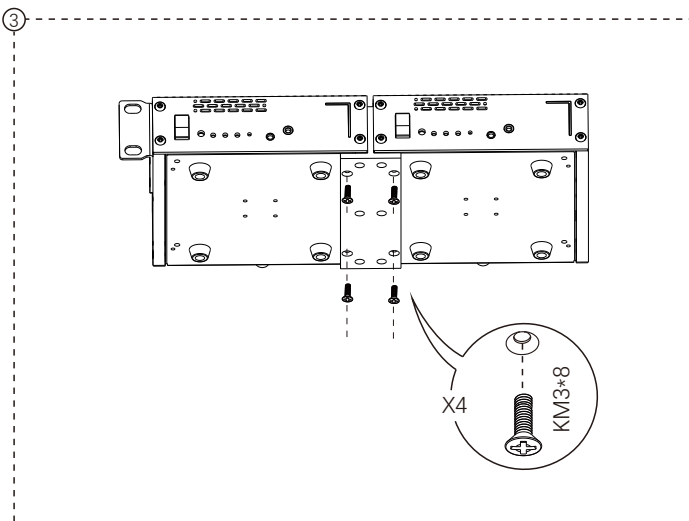
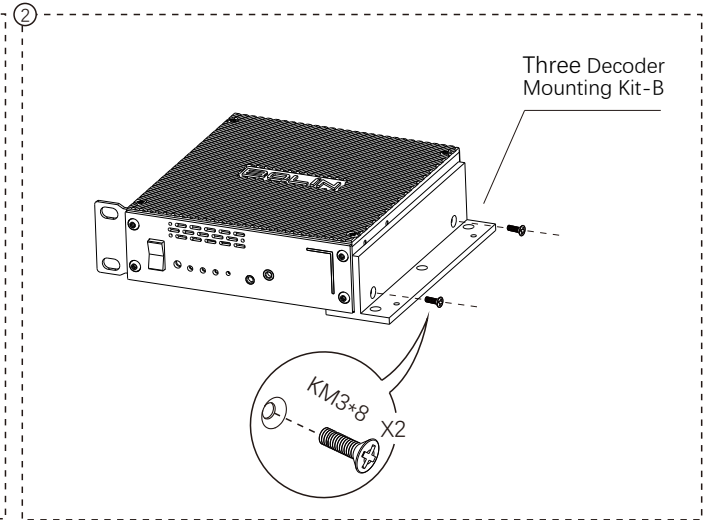
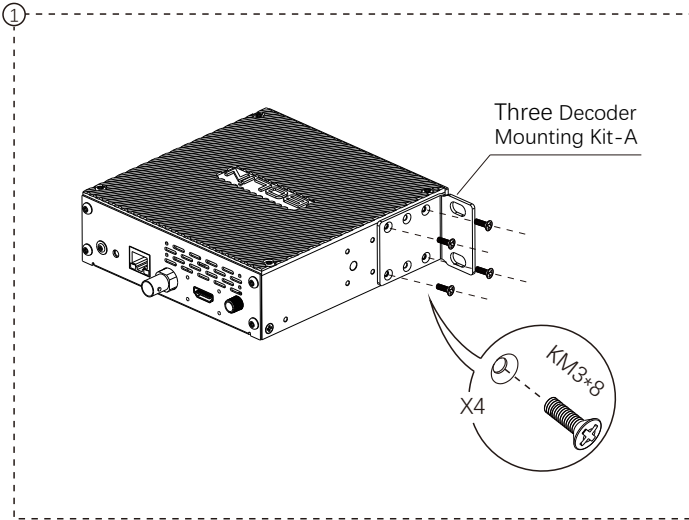

7

